

Assembly Instruction

10

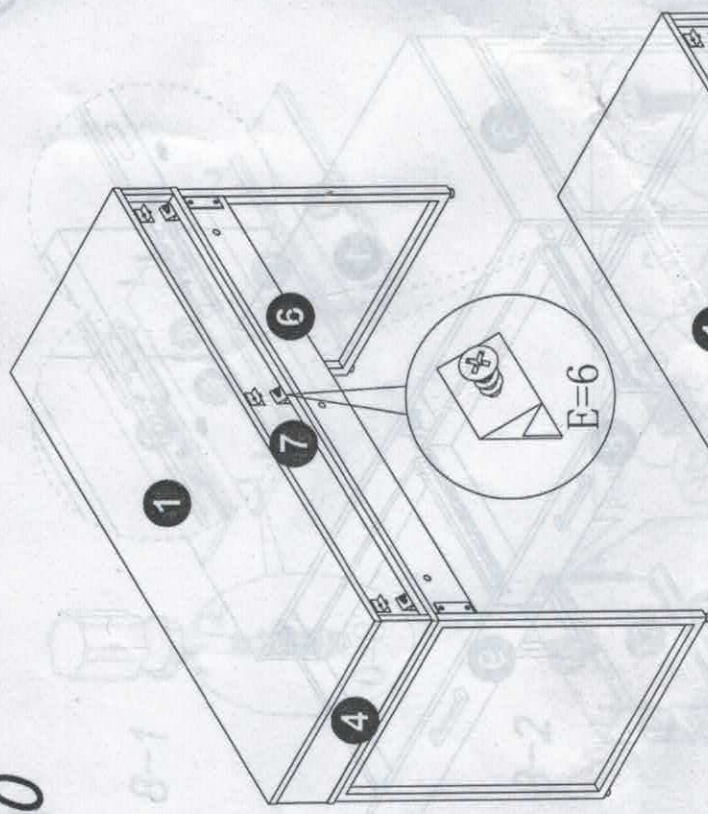

11

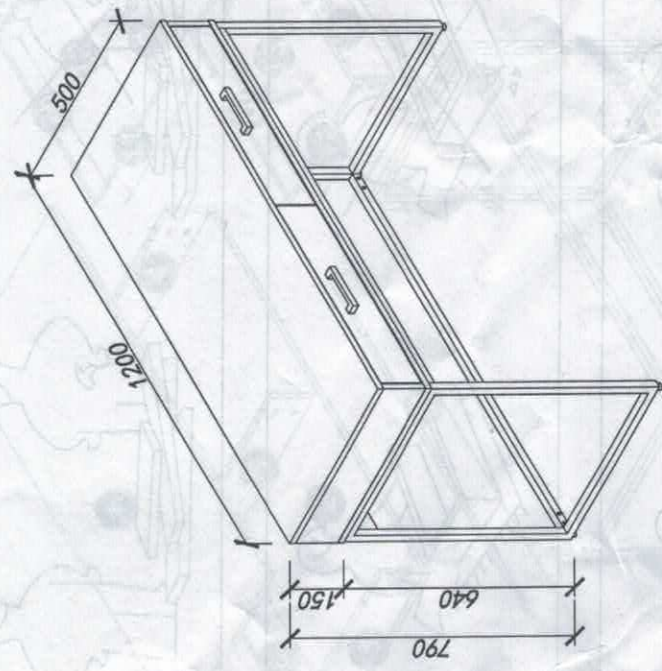
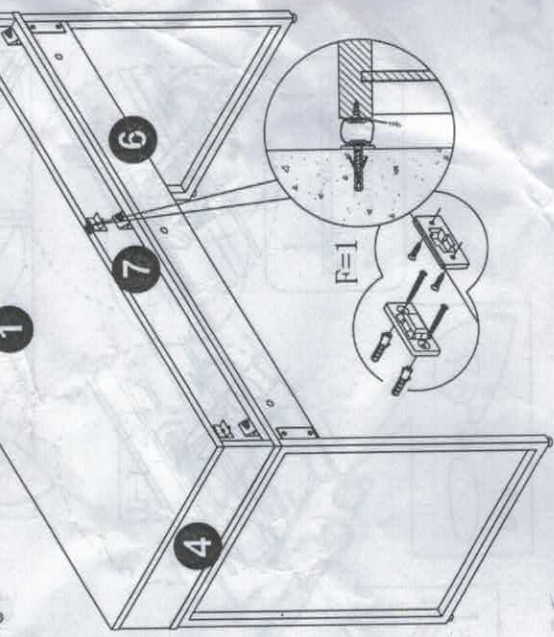

Fittings

Part No.	Description	Qty	Unit
A-15	1/4" x 1/2" x 1/8" Flat Head Phillips	1	
B-14	1/4" x 1/2" x 1/8" Flat Head Phillips	1	
C-15	1/4" x 1/2" x 1/8" Flat Head Phillips	1	
D-31	1/4" x 1/2" x 1/8" Flat Head Phillips	1	
E-6	1/4" x 1/2" x 1/8" Flat Head Phillips	1	

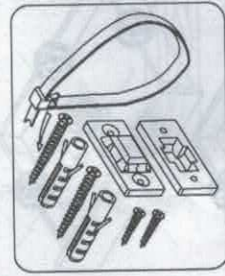

F=1



G1=15



H=1

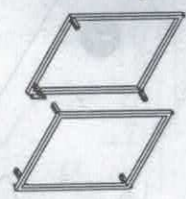

J-1=1

J-2=1

J-3=1

J-4=1



N=2



O=16



U=2



P=16



Z1=7



Z2=7



V1=16

1

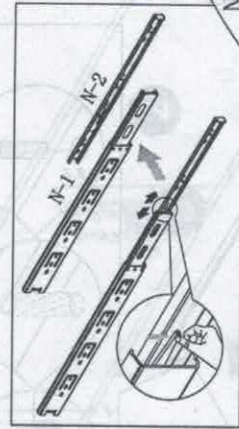

N-1=4



3

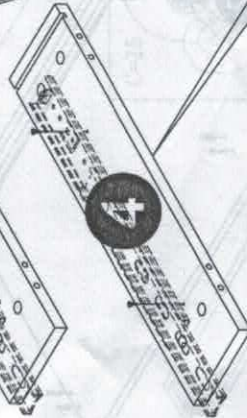

4

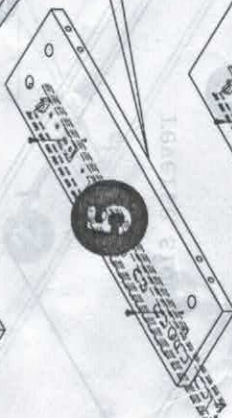

5

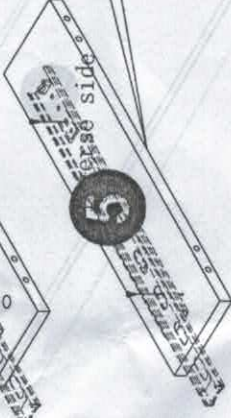

6

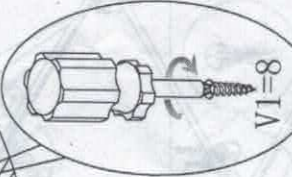

V1=8



Front
Back
hole location



Front
Back
hole location

Loose side

2

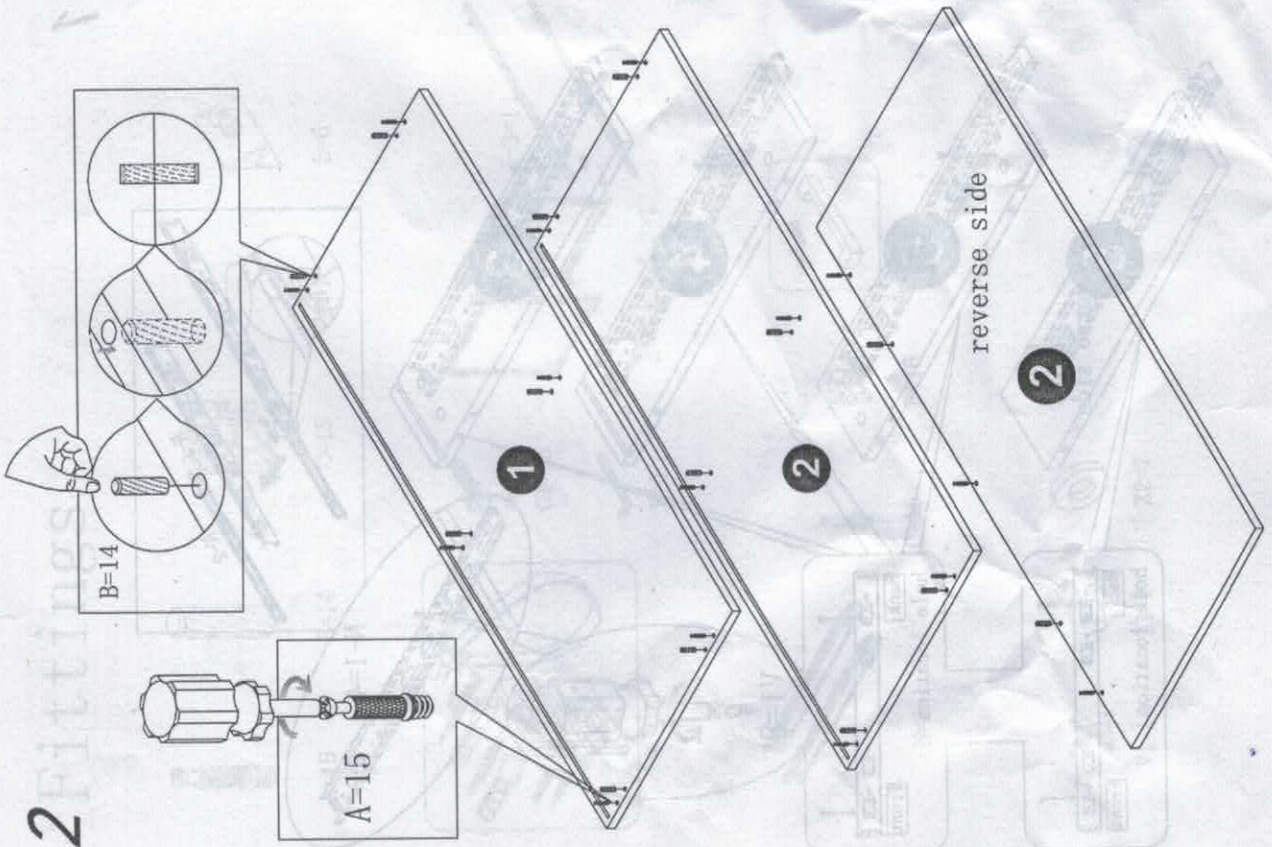

3

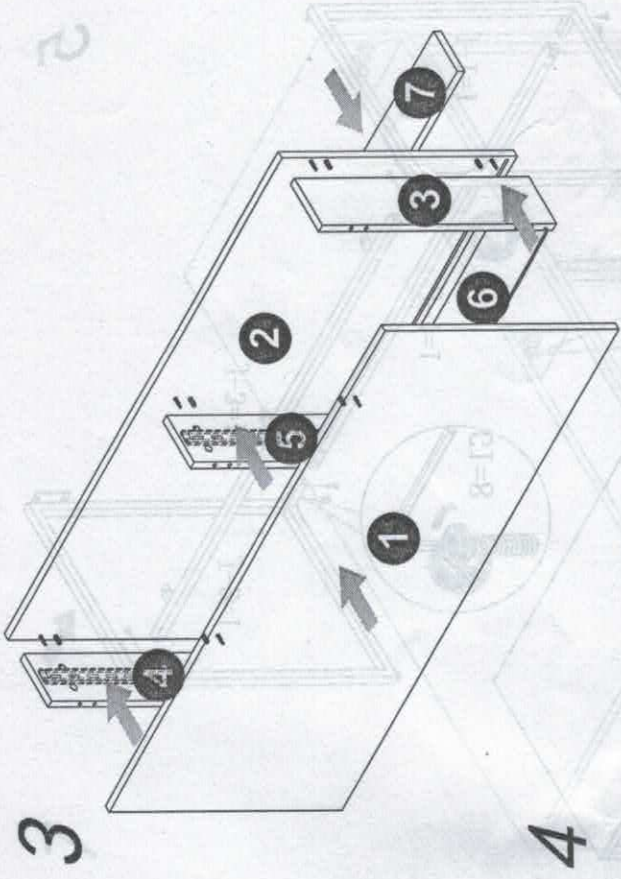

4

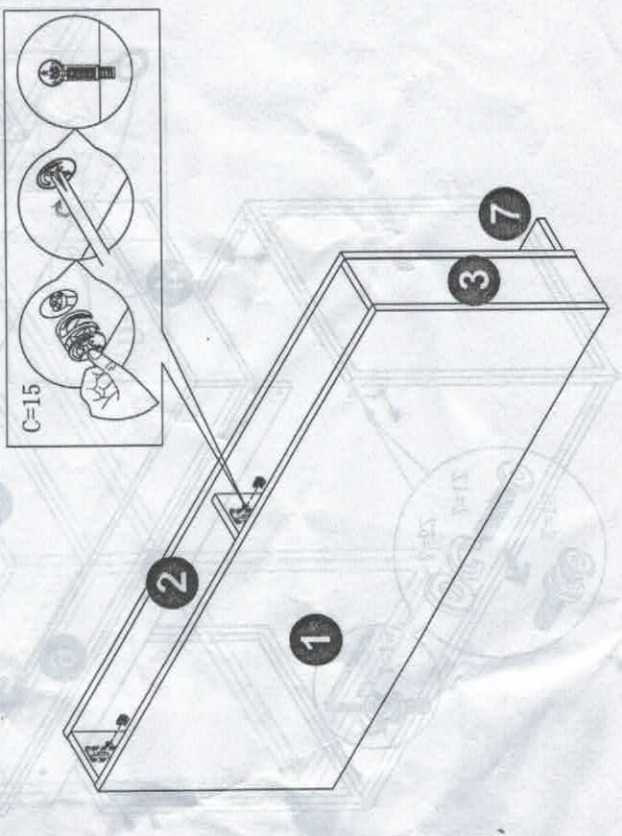

7

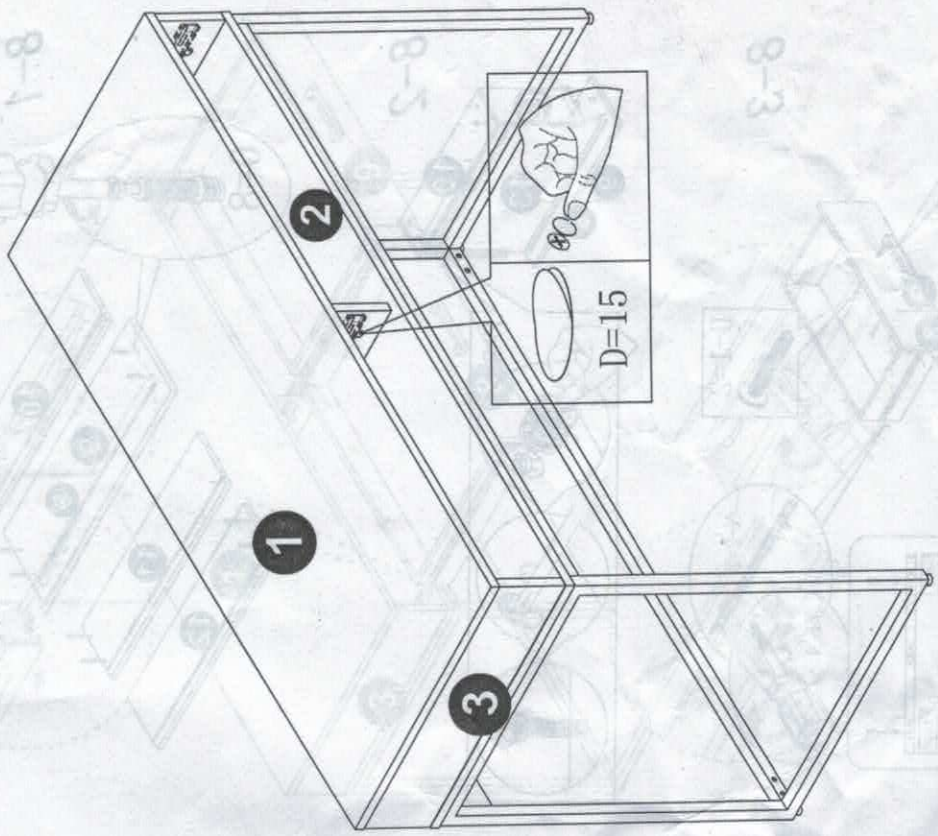

5

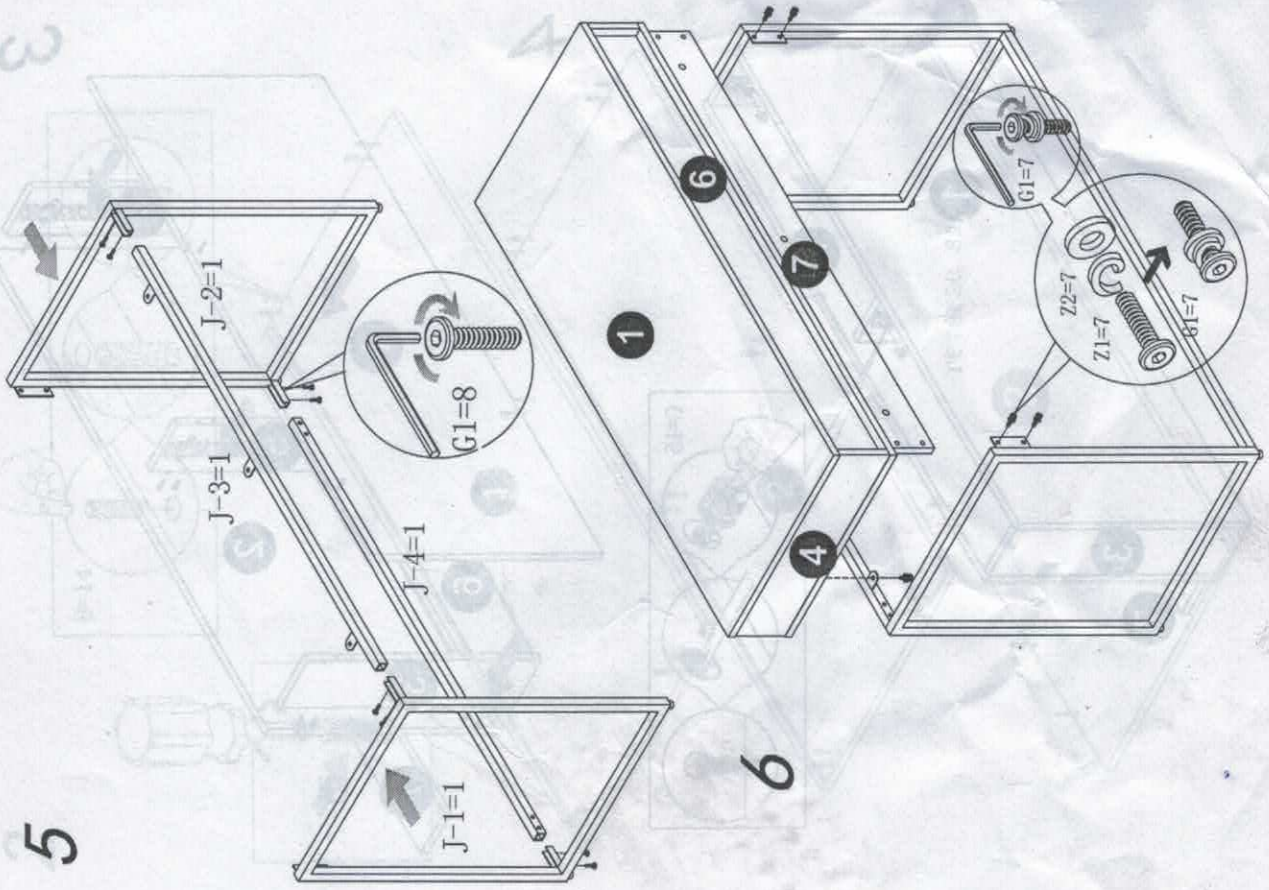

6

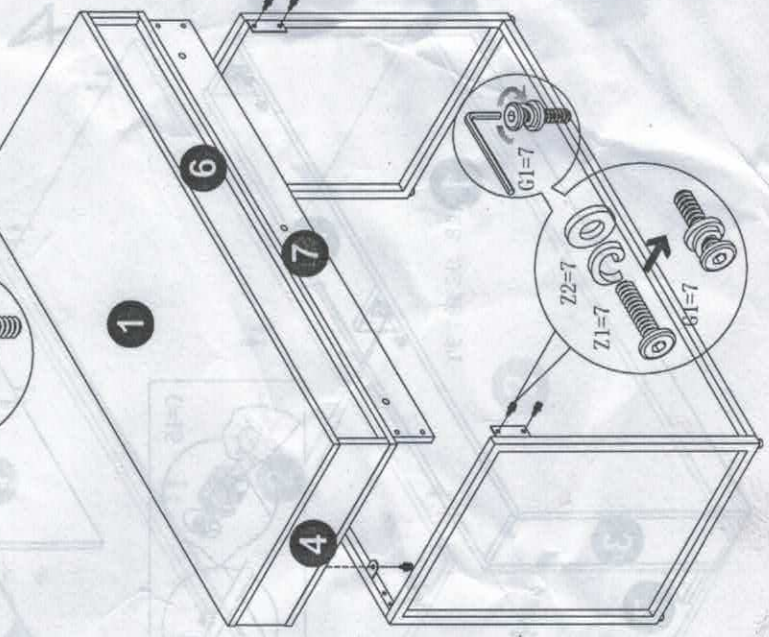

9

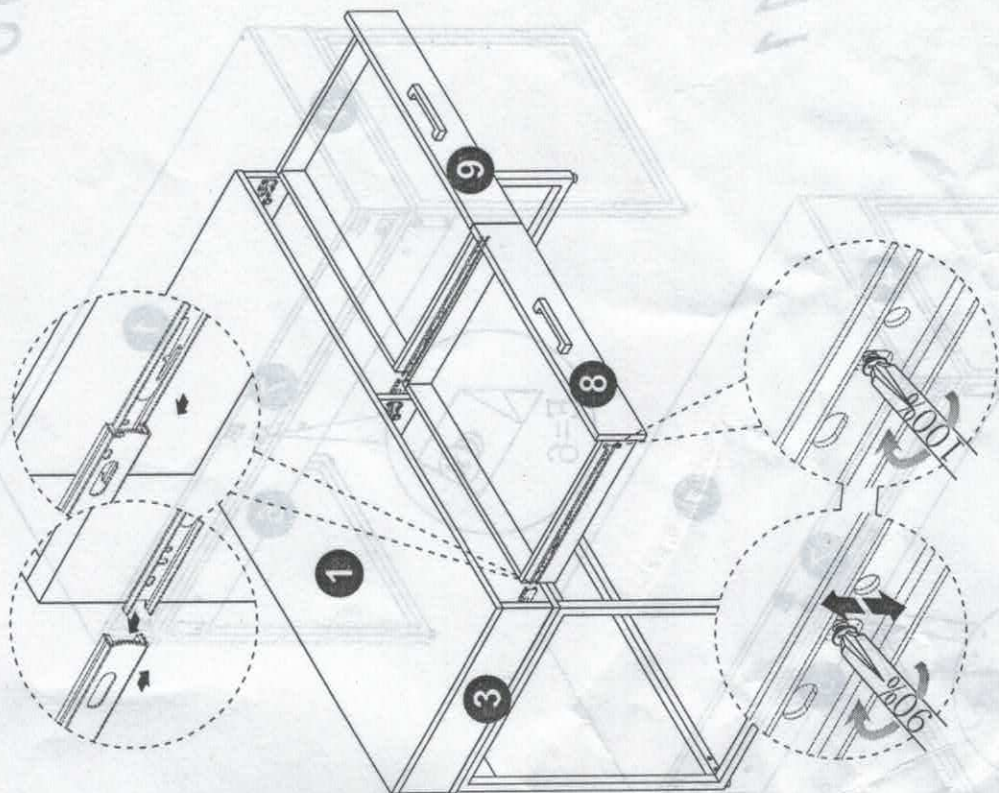

8

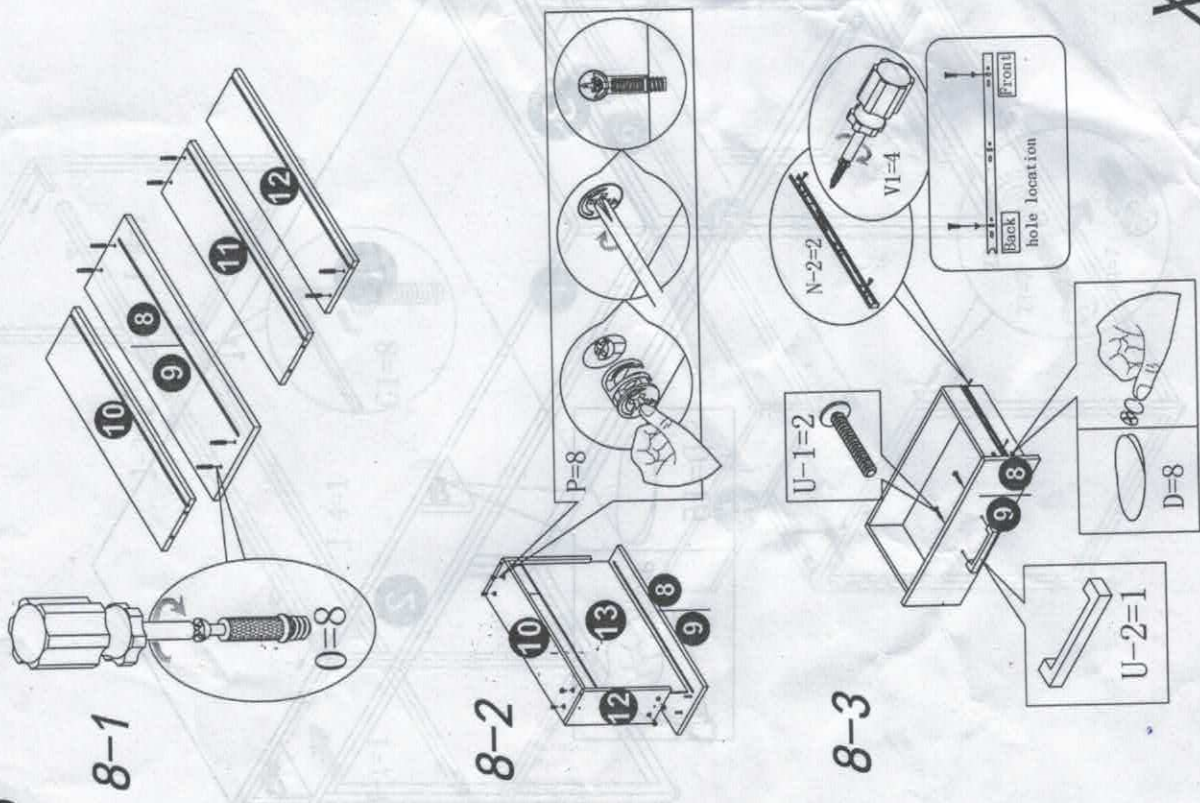

X2